



# INSTITUTE FOR ANIMAL HEALTH

## PIRBRIGHT LABORATORY

Telephone: +44 (0) 1483 232441

Fax: +44 (0) 1483 232621



*PRODUCT PRICE LIST  
AND  
DIAGNOSTIC SERVICE*

November 2011

## TABLE OF CONTENTS

INTRODUCTION.....	1
GENERAL INFORMATION .....	2
ORDERS.....	2
PACKAGING AND DESPATCH OF BIOLOGICAL MATERIALS .....	3
SUBMISSION OF SAMPLES FOR TESTING FROM UNITED KINGDOM.....	8
RESULTS .....	9
PRICES .....	9
PAYMENT .....	9
RETURNS .....	9
PRODUCT LIABILITY.....	10
LIVE AND INFECTIOUS MATERIALS .....	10
SCREENING AND DIAGNOSTIC TESTS .....	11
Foot-and-Mouth Disease.....	11
Swine Vesicular Disease.....	12
Vesicular Stomatitis .....	12
African Swine Fever .....	13
Rinderpest .....	13
Peste des Petits Ruminants .....	14
Bluetongue .....	14
African Horse Sickness.....	15
Epizootic Haemorrhagic Disease .....	15
Capripox (Sheep Pox, Goat Pox, Lumpy Skin Disease).....	16
SCREENING CELLS, SEED VIRUSES, VACCINES AND OTHER MATERIALFOR REGISTRATION PURPOSES .....	17
KITS AND REAGENTS .....	18
Foot and Mouth Disease .....	18
Swine Vesicular Disease.....	20
Vesicular Stomatitis .....	20
African Swine Fever .....	21
Rinderpest .....	21
Peste des Petits Ruminants .....	21
Bluetongue .....	22

African Horse Sickness .....	22
Epizootic Haemorrhagic Disease .....	23
Capripox.....	23

CONDITIONS OF SALE .....	24
1. Definitions and Interpretation .....	24
2. Conditions Applicable .....	25
3. Orders.....	25
4. Prices.....	26
5. Payment.....	27
6. Property.....	27
7. Risk .....	27
8. Insurance .....	28
9. The Products .....	28
10. Intellectual Property .....	29
11. Trademarks .....	29
12. Returns .....	29
13. Warning - Live and Infectious Products .....	29
14. Liability.....	30
15. Delivery.....	31
16. Loss in Transit.....	31
17. Import Documents.....	31
18. Storage .....	31
19. Cancellation by Client.....	31
20. Cancellation by IAH .....	32
21. Notices .....	32
22. Force Majeure .....	32
23. Sub-contracting .....	32
24. Waiver.....	32
25. Severance .....	33
26. Proper Law .....	33
27. Jurisdiction.....	33



## INTRODUCTION

The Institute for Animal Health (IAH), through its Pirbright Laboratory carries out work on animal virus diseases exotic to the United Kingdom. Many of the staff working in Pirbright Laboratory are international experts recognised by OIE, FAO, the EU and IAEA.

### **Pirbright is the designated**

#### **FAO World Reference Laboratory for:**

*Foot-and-Mouth Disease*  
*Morbilliviruses*

#### **EU Reference Laboratory for:**

*Bluetongue*  
*Swine Vesicular Disease*  
*Foot-and-Mouth Disease*

#### **OIE Reference Laboratory for:**

*Foot-and-Mouth Disease*  
*Swine Vesicular Disease*  
*African Swine Fever*  
*Bluetongue*  
*Rinderpest*  
*Peste des Petits Ruminants*  
*African Horse Sickness*  
*Capripox*

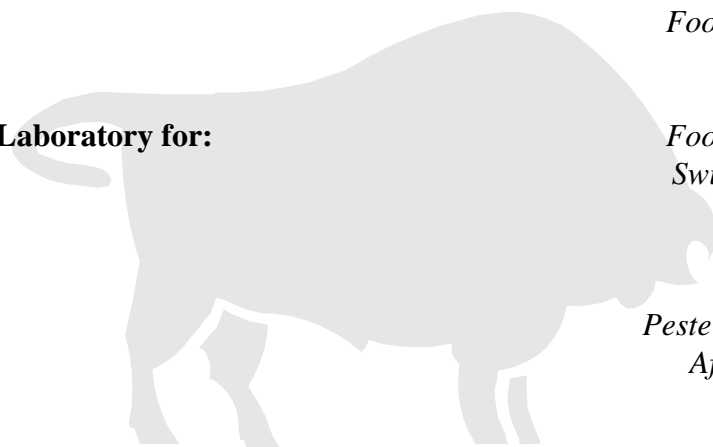

## **GENERAL INFORMATION**

### **ORDERS FOR REAGENTS AND KITS**

Reagents and kits from the Pirbright Laboratory can only be supplied to overseas customers. Overseas customers must ensure that all necessary import permits accompany the order.

Orders must specify the catalogue number and quantity of each item required, and be accompanied by the full address for delivery (and the invoice when these are different), including telephone and fax numbers.

The conditions of sale set out at the back of this catalogue on pages 23 to 32 shall apply to all orders.

All orders should be sent to:



Or

Tel: + 44 (0) 1483 232441

Fax: + 44 (0) 1483 232621

Or

Gareth.shimmon@iah.ac.uk

Elizabeth.wilson@iah.ac.uk

## **REQUIREMENTS FOR PACKAGING AND DESPATCH OF BIOLOGICAL MATERIALS TO THE INSTITUTE FOR ANIMAL HEALTH, PIRBRIGHT LABORATORY, UK FROM OVERSEAS**

The Department for Environment, Food and Rural Affairs licence allows the importation of biological material to IAH-Pirbright by AIRFREIGHT, normally to London Heathrow Airport. The Institute's nominated Broker will Customs 'clear' the shipment and it will be collected by a member of the institute staff so that no commercial freight companies are involved other than the airline.

If it is not possible to deliver samples by airfreight then a courier designated by the Pirbright Laboratory may be used if this has been agreed with the Pirbright Laboratory in advance of the shipment.

### **Availability of diagnostic services**

The laboratory offers an international diagnostic service for foot-and-mouth disease, swine vesicular disease, rinderpest, peste des petits ruminants, African swine fever, bluetongue, African horse sickness, sheep and goat pox and lumpy skin disease. Details of the services available are to be found on our website at:

<http://www.wrlfmd.org>

Testing carried out by WRLFMD is UKAS ISO/IEC 17025 accredited. Please see link for scope of accreditation. [http://www.ukas.org/testing/lab\\_detail.asp?lab\\_id=2811&location\\_id=&vMenuOption=3](http://www.ukas.org/testing/lab_detail.asp?lab_id=2811&location_id=&vMenuOption=3)

The free service for analysing samples from animals suspected to be infected with the above-mentioned viruses is available for up to 50 samples per country per year (except by prior agreement) and testing is carried out on behalf of the national regulatory authority, to whom results will be copied. OIE / FAO will also be informed. Results will be provided as soon as is practicably possible. Senders should be aware that samples will be processed subject to laboratory workload and priority of submission. In the event of a delay of 30 days from receipt in reporting initial serotyping results, the head of VDRL or the reference laboratory secretary shall inform the submitter by email or fax and advise on the expected date for reporting of those results.

Samples, virus isolates and deduced characteristics of the samples, such as genetic and antigenic data may be passed to others in order to facilitate international disease control and for the purpose of research into the development of improved disease control capabilities.

Before selecting biological material the sender should check with the relevant Department at Pirbright about the samples required and the conditions for despatch. Sample collection advice and sample submission forms for investigation of suspected cases of vesicular disease viruses are available on our website at:

<http://www.wrlfmd.org>

### **Notification of shipment**

Before despatch, the shipment details must be agreed with the Pirbright Laboratory who must be given the flight number, the Air Waybill number, the date and time of expected arrival in UK and a point of contact for queries and to whom test results will be provided (name, telephone number, fax number, e-mail address).

Contact with the Pirbright Laboratory should be made via:

Tel: +44 (0)1483 231014

Fax: +44 (0)1483 232621

e-mail: [elizabeth.wilson@iah.ac.uk](mailto:elizabeth.wilson@iah.ac.uk) [gareth.shimmon@iah.ac.uk](mailto:gareth.shimmon@iah.ac.uk)

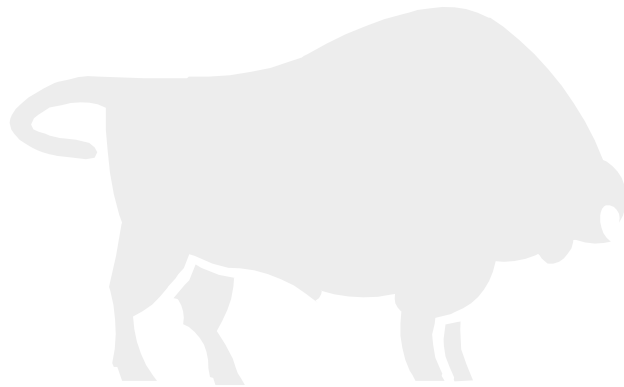

## **Packaging requirements**

Specimens for diagnosis of the pathogens listed above must be packaged according to PI650 requirement for UN3373 category B classification<sup>1</sup> unless exempt due to a minimal likelihood that pathogens are present (e.g. samples for serology)

It is essential that packaging ensures that the contents of containers, which break or leak in transit, cannot contaminate the outside layer of the parcel. Samples should be placed in a watertight primary container which should be individually wrapped in absorbent material and then placed in a watertight crush and leak proof secondary container. This may be surrounded by sealed freezer packs or dry ice<sup>2</sup> and must be enclosed in a strong outer packaging which should allow the release of carbon dioxide if card ice is enclosed.

A list of contents should be enclosed in a waterproof envelope between the secondary and outer packaging.

The parcel must only contain material that is to be processed at the Pirbright Laboratory, as none of the contents can be sent to other laboratories in the United Kingdom from the Pirbright Laboratory.

## **Labelling**

The outer packaging of the parcel must be clearly labelled with the following information as shown in the diagram below

- Our import licence number, AHZ/1309/A (a copy of which should also be attached within an envelope to the outside of the package)
- The name and address of the Institute and in the case of parcels sent by airfreight the instruction that the package is “Airfreight package for the attention of Moonbridge, Unit 304, Bedfont Industrial Park, Challenge Rd, Ashford, Middlesex, TW15 1AX”
- The name and telephone number of the person responsible for sending the parcel.
- Infectious Substance Hazard Label stating that the package contains a “Biological Substance, Category B” Animal Diagnostic Specimen of no Commercial Value (Hazard for Animal Health, not for people).
- Flight Number
- Air Waybill Number
- Dry Ice Label (if necessary).

**IAH, Pirbright Laboratory**

**7<sup>th</sup> April 2011**

---

<sup>1</sup> Cultures of the pathogens listed above must be packaged according to PI602 requirement for UN2900 category A classification

<sup>2</sup> Under no circumstances must dry ice be placed in sealed containers due to the risk of explosion

Customs Declaration

P  
E  
R  
I  
S  
H  
A  
B  
L  
E

**BIOLOGICAL SUBSTANCE,  
CATEGORY B**

Animal Diagnostic Specimen of no  
Commercial Value (Hazard for  
Animal Health, not for people)

TO:

Institute for Animal Health, Pirbright  
Laboratory, Ash Road, Pirbright,  
Woking, Surrey, GU24 0NF UK  
Tel: +44 (0)1483 232446

[Import Licence No.: AHZ/1309/A](#)

Airfreight package for the attention of  
Moonbridge, Unit 304, Bedfont  
Industrial Park, Challenge Rd,  
Ashford, Middlesex, TW15 1AX

Keep at 4°C unless otherwise instructed

F  
R  
A  
G  
I  
L  
E

Name of sender

.....  
.....  
.....  
.Phone number (24hr).....

DRY ICE UN1845 .....kg (net weight)

Flight number

Air Waybill number

**Example of Packing and Marking for Category B Infectious Substances  
(See Packing Instruction 650 for additional requirements)**

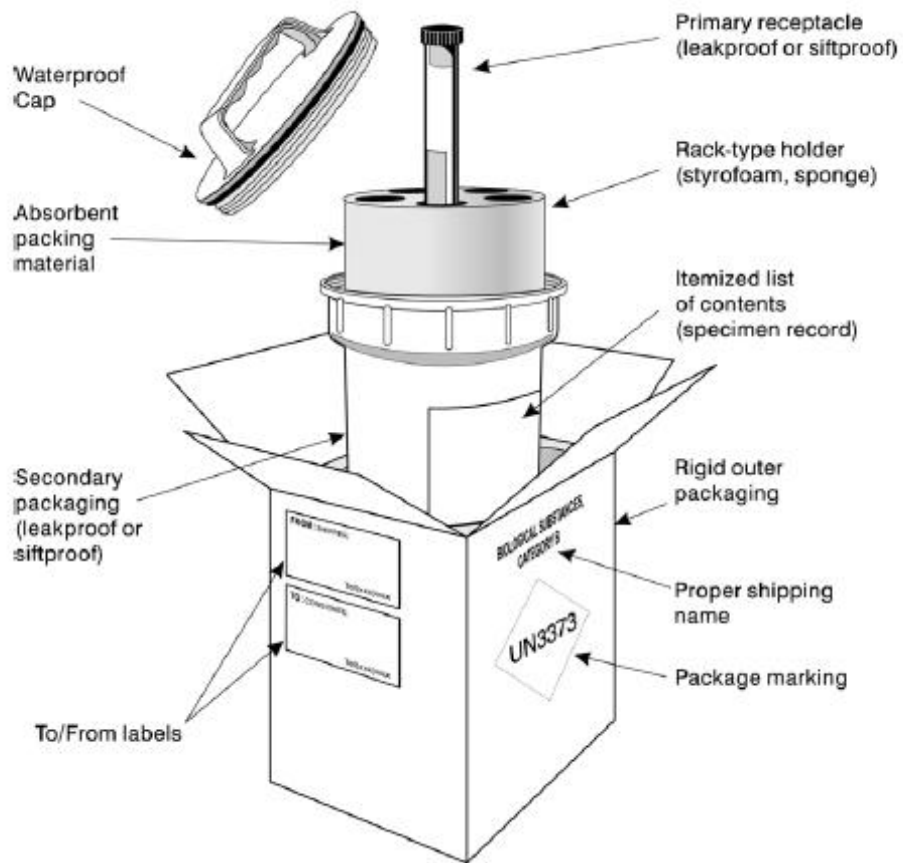

**Example of Packing and Marking for Category A Infectious Substances  
(See Packing Instruction P602 for additional requirements)**

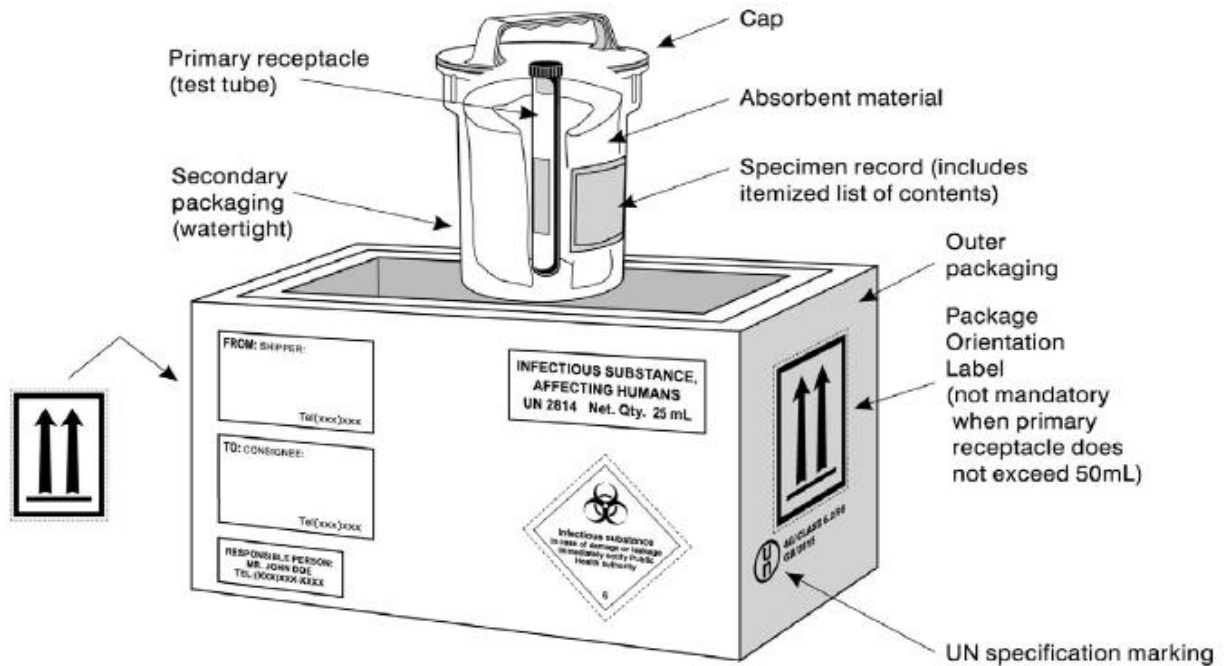

## **SUBMISSION OF SAMPLES FOR TESTING FROM UNITED KINGDOM**

Samples may be sent by post or special courier, but in all instances, notification must first be given by fax or telephone message that samples are being submitted. Samples must be securely packaged in leak-proof containers and adequate packing to prevent breakages.

Samples for testing from animals prior to or following, movement across international borders should be clearly identified, and for animals awaiting export, the country to which they are being exported and the date of export must be included.

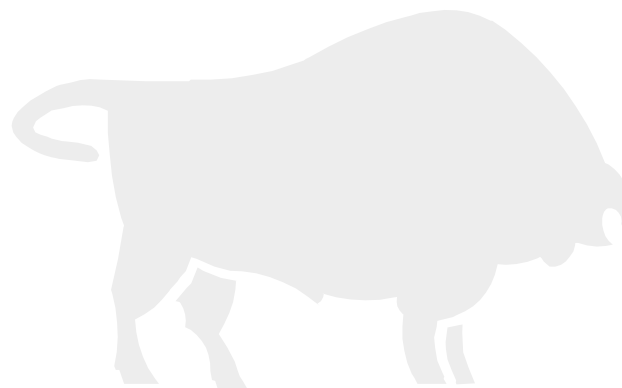

## **RESULTS**

At least 15 working days should be allowed from receipt of samples to completion of tests, although this can be shorter by prior arrangement to comply with quarantine and licensing obligations.

Results will be sent by either fax or email depending on which is supplied on the submission paperwork.

## **PRICES**

The price charged will be that prevailing at the time of despatch.

All prices are exclusive of VAT. For EU orders and test results please provide a VAT registration number, otherwise VAT will be charged at the UK prevailing rate.

Delivery costs and the cost of clearance and collection of samples from the airport are not included in the catalogue price, and will be charged at cost. (see p 25, 4.10)

We reserve the right to amend prices without notification.

## **PAYMENT**

Payment is due on receipt of the invoice, in sterling, by bankers order or cheque drawn on a UK clearing bank made payable to "Institute for Animal Health", or directly into the IAH bank account as follows:

Lloyds Bank

Sort Code: 30-98-41

Account No: 00468305

Please ensure you give a sales invoice number when you make a payment. Payments submitted without this information will create a delay in clearing to your account. The Institute for Animal Health is one of the Research Councils of the UK whose finances are managed by the Shared Services Centre (RCUK SSC Ltd.). The company supplying goods and receiving payment remains the Institute for Animal Health.

In some cases it will be necessary to clear payment before despatch.

**Unless otherwise stated, and agreed in writing, property and title of the goods will not pass to the customer until the whole price has been received by the Institute.**

## **RETURNS**

Biological products are not generally accepted for return. Should the need arise please contact the Sales Department at the address shown on page 2 before sending any goods for return to IAH.

## **PRODUCT LIABILITY**

Products listed in this brochure are intended for use as *in vitro* diagnostic material or for research, manufacturing or quality control testing, except those products clearly specified in the catalogue for use in *in vivo* diagnostic procedures or for disease prophylaxis. It is the responsibility of the user to ensure that they possess the necessary technical skills to determine the appropriateness of these products for the proposed application. IAH accepts no responsibility for results obtained from these products, as their efficacy depends on conditions of use and the variability of other materials used which are beyond the control of the Institute.

In no event will IAH be held responsible for the loss of profits, or for indirect or consequential loss including, but not limited to, personal injury arising from the use of these products.

**Customers are advised that IAH accepts no responsibility for the non-delivery of goods or for damages in transit unless it can be proved to have resulted from its negligence. Claims for goods damaged in transit should be made within 3 working days of receipt. Any replacements are made strictly as an act of goodwill, and should in no way be construed as an acceptance of liability by the Institute**

## **LIVE AND INFECTIOUS MATERIALS**

Some of the products in this brochure are infectious. Please ensure that:

- *all necessary precautions are taken when handling live infectious material.*
- *full operator safety precautions are observed when handling material which may be infectious to humans.*
- *operators are fully informed as to the nature of the material they are handling.*
- *instructions for use and safe disposal are carried out.*
- *overseas orders are accompanied by all the import documents necessary for this class of materials.*

## SCREENING AND DIAGNOSTIC TESTS

### Foot-and-Mouth Disease

<u>Samples for virus detection</u>	<u>Test</u>	<u>Charge per test (£)</u>			<u>Code No</u>
		<u>≤ 10</u>	<u>≤ 40</u>	<u>41+</u>	
Probangs	TC*	58.00	51.00	45.00	<b>S0101</b>
Embryo washing	TC	58.00	51.00	45.00	<b>S0102</b>
Semen (per batch of 5-10 straws)	TC	58.00	51.00	45.00	<b>S0104</b>
Other Tissues	TC	58.00	51.00	45.00	<b>S0105</b>
Miscellaneous samples e.g bone meal, vaccines	TC	P O A			<b>S0106</b>
Samples from suspected infected animals	TC + ELISA PCR***	F O C** F.O C			<b>S0107</b>
Nucleotide Sequencing (segment of VP1 gene)		320			<b>S0108</b>

### Samples for Antibody Detection

		<u>Charge per serotype (£)</u>			
		<u>≤ 50</u>	<u>≤ 100</u>	<u>101+</u>	
Serum -Spot test	Liquid Phase Blocking ELISA	16.00	13.00	8.00	<b>S0109</b>
-Titration	Liquid Phase Blocking ELISA	22.50	16.00	12.00	<b>S0110</b>
	VNT	38.00	31.00	22.50	<b>S0111</b>
	Cedi O ELISA	<u>≤ 40</u> 12.00	<u>≤ 80</u> 10.00	<u>81+</u> 8.00	<b>SO114</b>

### Non-structural Protein NSP Testing

	<u>Charge per block batch (£)</u>	
1- 40 samples = £358.00	41- 80 samples = £445.00	
81-120 samples = £530.00	121-160 samples = £616.00	
161-200 samples = £702.00		<b>S0112</b>

### Testing of commercial material

	<u>Charge per sample (£)</u>	
To prove the absence of infectious virus	992.00 per sample	<b>S0113*</b>

\* Tissue Culture

\*\* Free of Charge

\*\*\* Polymerase Chain Reaction

**The free service for analysing samples from animals suspected to be infected with a vesicular virus infection (FMDV and its differential diagnosis) is available for up to 50 samples per country per year except by prior agreement) and testing is carried out on behalf of the national regulatory authority, to whom results will be copied. OIE / FAO will also be informed. Samples and deduced characteristics of the samples, such as genetic and antigenic data may be passed to others in order to facilitate international disease control and for the purpose of research into the development of improved disease control capabilities.**

### Swine Vesicular Disease

<u>Samples for virus detection</u>	<u>Test</u>	<u>Charge per test (£)</u>			<u>Code No</u>
		<u>≤ 10</u>	<u>≤ 40</u>	<u>41+</u>	
Semen (per batch of 5-10 straws)	TC + ELISA	58.00	51.00	45.00	<b>S0201</b>
Nucleotide Sequencing (part of VP1 gene)		320			<b>S0202</b>
Samples from suspected					
infected animals	TC + ELISA	FOC			<b>S0203</b>
Samples for antibody detection					
	<u>Test</u>	<u>Charge per test (£)</u>			
		<u>≤ 50</u>	<u>≤ 100</u>	<u>101+</u>	
Spot test	ELISA	16.00	13.00	8.00	<b>S0204</b>
Titration	VNT	38.00	31.00	22.50	<b>S0205</b>

### Vesicular Stomatitis

<u>Samples for virus detection</u>	<u>Test</u>	<u>Charge per test (£)</u>			<u>Code No</u>
		<u>≤ 50</u>	<u>≤ 100</u>	<u>101+</u>	
Samples from suspected					
infected animals	TC + ELISA	FOC			<b>S0301</b>
Samples for antibody detection					
	<u>Test</u>	<u>Charge per serotype (£)</u>			
		<u>≤ 50</u>	<u>≤ 100</u>	<u>101+</u>	
Serum	VNT	38.00	31.00	22.50	<b>S0302</b>

The free service for analysing samples from animals suspected to be infected with a vesicular virus infection (FMDV and its differential diagnosis) is available for up to 50 samples per country per year except by prior agreement) and testing is carried out on behalf of the national regulatory authority, to whom results will be copied. OIE / FAO will also be informed. Samples and deduced characteristics of the samples, such as genetic and antigenic data may be passed to others in order to facilitate international disease control and for the purpose of research into the development of improved disease control capabilities.

### **African Swine Fever**

<u>Samples for virus detection</u>	<u>Test</u>	<u>Charge per test (£)</u>			<u>Code No</u>
		<u>1-10</u>	<u>11+</u>		
Samples from suspected infected animals	HAD in primary cultures of pig bone marrow	FOC			<b>S0401</b>
Pig Blood or Post-mortem Tissues for ASF virus screening	) ) ) HAD in primary cultures of pig bone marrow	58.00	51.00		<b>S0402a</b>
		<u>≤ 5</u>	<u>≤ 20</u>	<u>21+</u>	
	Real Time PCR	60	40	20	<b>S0402b</b>

<u>Samples for antibody detection</u>	<u>Test</u>	<u>Charge per test (£)</u>			
		<u>≤ 5</u>	<u>≤ 20</u>	<u>21+</u>	
Serum	ELISA	60	40	20	<b>S0403</b>

### **Rinderpest**

<u>Samples for virus detection</u>	<u>Test</u>	<u>Charge per test (£)</u>			<u>Code No</u>
Samples from suspected infected animals	PCR		FOC		<b>S0502</b>
		<u>≤ 5</u>	<u>≤ 20</u>	<u>21+</u>	
Serum	ELISA	60	40	20	<b>S0504</b>

**The free service for analysing samples from animals suspected to be infected with a vesicular virus infection (FMDV and its differential diagnosis) is available for up to 50 samples per country per year except by prior agreement) and testing is carried out on behalf of the national regulatory authority, to whom results will be copied. OIE / FAO will also be informed. Samples and deduced characteristics of the samples, such as genetic and antigenic data may be passed to others in order to facilitate international disease control and for the purpose of research into the development of improved disease control capabilities.**

### Peste des Petits Ruminants

<u>Samples for virus detection</u>	<u>Test</u>	<u>Charge per test (£)</u>			<u>Code No</u>
Samples from suspected infected animals	PCR	FOC			<b>S0602</b>

<u>Samples for antibody detection</u>	<u>Test</u>	<u>Charge per test (£)</u>			
		<u>≤ 5</u>	<u>≤ 20</u>	<u>21+</u>	
Serum	ELISA	60	40	20	<b>S0603</b>

### Bluetongue

<u>Samples for virus detection</u>	<u>Test</u>	<u>Charge per test (£)</u>			<u>Code No</u>
Samples from suspected infected animals	PCR	FOC			<b>S0709</b>

Whole Blood or post mortem samples	TC	POA			
	Egg inoculation	POA			

### BTV group identification

PCR-Pre Movement testing (EDTA blood)	Real-time PCR	<u>1</u> 30.00	<u>2-9</u> 25.00	<u>10+</u> 22.50	<b>S0706</b>
---------------------------------------	---------------	-------------------	---------------------	---------------------	--------------

Bluetongue virus serotype	Nucleotide sequencing	POA			
---------------------------	-----------------------	-----	--	--	--

<u>Samples for antibody detection</u>	<u>Test</u>	<u>Charge per test (£)</u>			
Serotyping specific antibodies	SNT	30 /serotype			<b>S0708</b>

Serum	IDVET Early Detection	<u>≤10</u> 16.00	<u>≤50</u> 12.00	<u>51+</u> 8.00	<b>S0719</b>
-------	-----------------------	---------------------	---------------------	--------------------	--------------

	ID-VET Milk ELISA	<u>≤ 5</u> 60.00	<u>≤ 20</u> 40.00	<u>21+</u> 20.00	<b>S0717</b>
--	-------------------	---------------------	----------------------	---------------------	--------------

The free service for analysing samples from animals suspected to be infected with a vesicular virus infection (FMDV and its differential diagnosis) is available for up to 50 samples per country per year except by prior agreement) and testing is carried out on behalf of the national regulatory authority, to whom results will be copied. OIE / FAO will also be informed. Samples and deduced characteristics of the samples, such as genetic and antigenic data may be passed to others in order to facilitate international disease control and for the purpose of research into the development of improved disease control capabilities.

### African Horse Sickness

<u>Samples for virus detection</u>	<u>Test</u>	<u>Charge per test (£)</u>			<u>Code No</u>
Samples from suspected infected animals	PCR	FOC			<b>S0808</b>
Whole Blood or Post Mortem samples	TC	POA			
	Egg inoculation	POA			
		<u>≤ 5</u>	<u>≤ 20</u>	<u>21+</u>	
Group Identification	PCR	60.00	40.00	20.00	<b>S0811</b>
Serotype identification	PCR	POA			<b>S0809</b>
Nucleotide sequencing	PCR	POA			<b>S0810</b>
<u>Samples for antibody detection</u>	<u>Test</u>	<u>Charge per test (£)</u>			
		<u>≤ 5</u>	<u>≤ 20</u>	<u>21+</u>	
	*Ingenasa ELISA	60.00	40.00	20.00	<b>S0812</b>

### Epizootic Haemorrhagic Disease

<u>Samples for virus detection</u>	<u>Test</u>	<u>Charge per test (£)</u>			<u>Code No</u>
Samples from suspected infected Animals	PCR	FOC			<b>S0908</b>
Whole Blood or post mortem samples	T.C.	POA			
	Egg inoculation	POA			
		<u>≤ 5</u>	<u>≤ 20</u>	<u>21+</u>	
Group identification	PCR	60.00	40.00	20.00	<b>S0911</b>
Serotype identification	PCR	POA			<b>S0905</b>
Nucleotide sequencing	PCR	POA			<b>S0909</b>
<u>Samples for antibody detection</u>	<u>Test</u>	<u>Charge per test (£)</u>			
		<u>≤ 5</u>	<u>≤ 20</u>	<u>21+</u>	
	LSI B'ELISA	60.00	40.00	20.00	

The free service for analysing samples from animals suspected to be infected with a vesicular virus infection (FMDV and its differential diagnosis) is available for up to 50 samples per country per year except by prior agreement) and testing is carried out on behalf of the national regulatory authority, to whom results will be copied. OIE / FAO will also be informed. Samples and deduced characteristics of the samples, such as genetic and antigenic data may be passed to others in order to facilitate international disease control and for the purpose of research into the development of improved disease control capabilities.

**Capripox (Sheep Pox, Goat Pox, Lumpy Skin Disease)**

<u>Samples for virus detection</u>	<u>Test</u>	<u>Charge per test (£)</u>			<u>Code No</u>
		<u>1-10</u>	<u>11-40</u>	<u>41+</u>	
Samples from suspected infected animals	PCR	FOC			<b>S1007</b>
Biopsy on post- mortem material	TC	58.00	51.00	45.00	<b>S1001</b>
	ELISA	31.00	25.50	21.50	<b>S1002</b>
	Electron microscopy	77.00			<b>S1003</b>
<u>Samples for antibody detection</u>	<u>Test</u>	<u>Charge per test (£)</u>			
		<u>1-50</u>	<u>51-100</u>	<u>101+</u>	
Serum	VNT	38.00	31.00	22.50	<b>S1006</b>
Serum	SNT	38.00	31.00	22.50	<b>S1008</b>

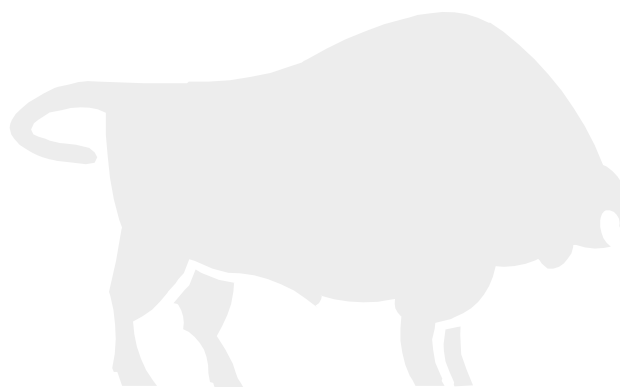

**The free service for analysing samples from animals suspected to be infected with a vesicular virus infection (FMDV and its differential diagnosis) is available for up to 50 samples per country per year except by prior agreement) and testing is carried out on behalf of the national regulatory authority, to whom results will be copied. OIE / FAO will also be informed. Samples and deduced characteristics of the samples, such as genetic and antigenic data may be passed to others in order to facilitate international disease control and for the purpose of research into the development of improved disease control capabilities.**

## **SCREENING CELLS, SEED VIRUSES, VACCINES AND OTHER MATERIAL FOR REGISTRATION PURPOSES**

Drugs, vaccines and other material can be screened for evidence of contamination with FMD, BT, VS, SVD, EHD, Rinderpest, PPR, AHS, BVD or Pox Viruses. The cost of these screening tests is negotiable, depending on which tests are required

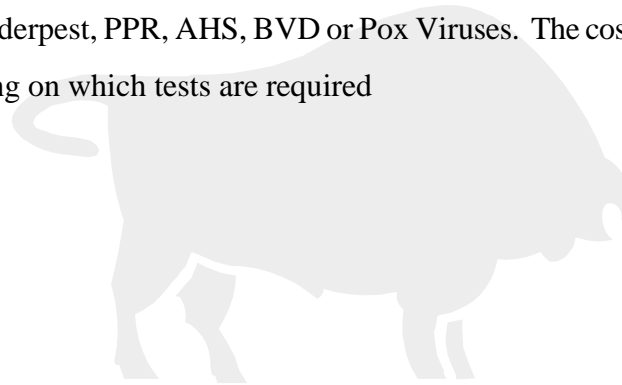

## KITS AND REAGENTS

### Foot and Mouth Disease

#### FMD Collecting Kits

**Code No: R5101**

Kits are free of charge, but handling and freight costs incurred by the Institute in despatching the kits will be charged, (minimum £100, paid in advance).

#### Reagents

Non-concentrated, non-purified antigen\* £42.00/ml **Code No: R5102**  
(e.g. for Antigen detection ELISA)

Concentrated, purified antigen\* £395.00/100µg **Code No: R5103**  
(e.g. for antiserum production)

Semi-purified antigen (Diluted 1:10)\* £48.00/ml **Code No: R5111**  
(e.g. for Antibody detection ELISA)

Rabbit and Guinea Pig type specific anti-146S (purified virus) £210.00/ml **Code No: R5104**

Positive bovine serum £58.00/ml **Code No: R5105**

Negative bovine serum £48.00/ml **Code No: R5110**

\* **All antigens are aziridine inactivated**

#### FMD Vaccine Tests

**Code No: R5106**

FMD vaccines can be examined using a variety of tests to estimate antigen content, innocuity and potency. Prices should be agreed prior to submission and are dependent on the tests requested.

Reference Sera £85.00/serum **Code No: R5107**

Four control positive reference sera are available for serotypes O, A and C plus a negative control serum.  
(Usually supplied in amounts of 0.5ml)

ELISA kits for FMDV antigen detection **Code No: R5108**

ELISA kit for FMDV antigen detection can be supplied through Biological Diagnostic Supplies Ltd, 25 Main Street, Dreghorn, Irvine, Ayrshire KA11 4AQ, Scotland, UK.

(Tel: 44-01294-224888, Fax: 44-01294-224999; e-mail: mail@bdsl.uk.com)

A kit of 7 serotypes will allow a minimum of 360 samples to be tested (one plate per assay -

control antigens plus 3 test samples). More samples can be tested if more than one plate is used per assay (second and subsequent plates - no controls, 5 test samples).

A kit for 3 or 4 serotypes will allow a minimum of 720 samples to be tested (one plate per assay - control antigens plus 6 test samples). More samples than one plate per assay - second and subsequent plates, no controls, 10 test samples).

LPB ELISA kits for FMDV antibody detection

**Code No: R5109**

ELISA kit for FMDV antibody detection can be supplied through Biological Diagnostic Supplies Ltd,

25 Main Street, Dreghorn, Irvine, Ayrshire KA11 4AQ, Scotland, UK.

(Tel: 44-01294-224888, Fax: 44-01294-224999; e-mail: mail@bdsl.uk.com)

Spot test

40 sera can be tested per plate: a total of 4800 sera per kit, for a single serotype. If reagents are required to test sera for antibodies to more than one serotype, divide 4800 by the number of serotypes to be tested i.e. one kit would test 1600 sera for antibodies to serotype O, A and C.

Titration assay

Up to 10 sera can be tested per plate; a total of 1200 sera per kit.

The combination of spot and titration assays (and the number of serotypes) will determine the number of sera which can be tested with a kit.

### **Swine Vesicular Disease**

<u>Reagents</u>		<u>Code No</u>
Non-concentrated, non purified antigen	£42.00/ml	<b>R5201</b>
Concentrated, purified antigen	£395.00/100µg	<b>R5202</b>
Rabbit and Guinea Pig antisera (purified virus)	£210.00/ml	<b>R5203</b>
<u>Reference Sera</u>		
Six control reference sera for SVD serology including negative (6 x 0.5ml)	£85.00/serum	<b>R5208</b>
Positive pig serum	£58.00/ml	<b>R5209</b>
Negative pig serum	£48.00/ml	<b>R5210</b>

### **Reagents for the 5B7 SVD antibody competition ELISA**

The Istituto Zooprofilattico Sperimentale della Lombardia e dell'Emilia, (IZSLE) Brescia has provided the Community Reference Laboratory (CRL) for SVD with the clone of the 5B7 monoclonal antibody on which the SVD monoclonal antibody competition ELISA is based. The CRL now produces the reagents necessary for performing the competition ELISA. These reagents are available only to the National SVD Reference Laboratories of EU Member States at the subsidised rate shown:

Laboratories outside the EU should contact the Virology Department of the IZSLE directly for supply of reagents (Fax: + 39 30 242 5251).

<u>Reagent</u>	<u>Cost (£/ml)</u>	<u>Code No</u>
5B7 Purified IgG (as capture antibody)	42.00	<b>R5205</b>
5B7 HRP-conjugated detector antibody	105.00	<b>R5206</b>
SVD Virus Inactivated antigen	32.00	<b>R5207</b>

### **Vesicular Stomatitis**

		<u>Code No</u>
<u>ELISA kits for VSV antigen detection</u>	£2920.00	<b>R5301</b>
Detection of antigen of VS virus New Jersey, Indiana 1,2 and 3		
The kit will allow a minimum of 720 samples to be tested.		

#### Reagents

Rabbit and Guinea Pig antisera	£210.00/ml	<b>R5302</b>
--------------------------------	------------	--------------

### **African swine fever**

Control positive serum	£90.00/ml	<b>R5401</b>
------------------------	-----------	--------------

### **Rinderpest**

ELISA kit for RP antibody detection can be supplied through Biological Diagnostic Supplies Ltd,  
25 Main Street, Dreghorn, Irvine, Ayrshire KA11 4AQ, Scotland, UK.

(Tel: 44-01294-224888, Fax: 44-01294-224999; e-mail: mail@bdsl.uk.com)

### **Reagent**

Hyperimmune rabbit sera	£90.00/ml	<b>R5502</b>
-------------------------	-----------	--------------

Negative rabbit sera	£63.00/ml	<b>R5503</b>
----------------------	-----------	--------------

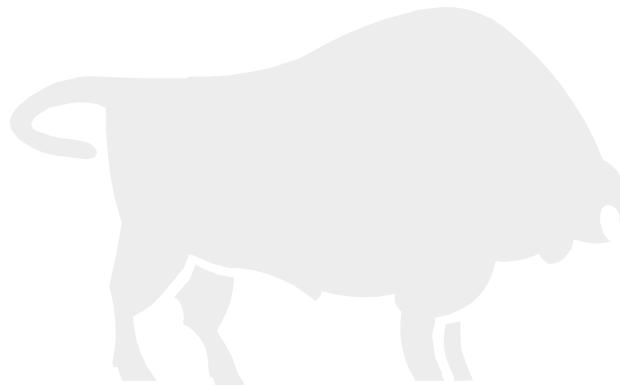

## **Bluetongue**

## **Code No**

### **ELISA Reagents**

Rabbit capture antiserum	£90.00/ml	<b>R5702</b>
Guinea-pig detecting antiserum	£90.00/ml	<b>R5703</b>
Anti BTV Monoclonal antibody	£195.00/ml	<b>R5706</b>
Convalescent sheep sera (serotype specific)	£63.00/ml	<b>R5707</b>
Negative sheep sera	£63.00/ml	<b>R5708</b>

## **African Horse Sickness**

### **Reagents**

Convalescent horse sera (serotype specific)	£63.00/ml	<b>R5802</b>
Negative horse sera	£63.00/ml	<b>R5803</b>

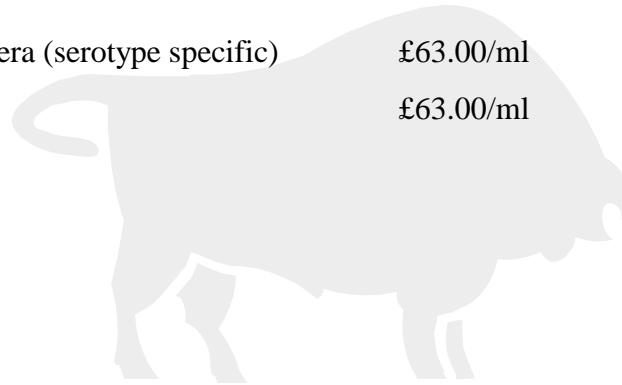

## **Epizootic Haemorrhagic Disease**

		<b><u>Code No</u></b>
<b><u>ELISA Reagents</u></b>		
Rabbit Capture antiserum	£90.00/ml	<b>R5902</b>
Guinea-pig detecting antiserum	£90.00/ml	<b>R5903</b>
Monoclonal antibody	£195.00/ml	<b>R5906</b>

## **Capripox**

### **Reagents**

Control positive serum for sheep pox, goat pox and lumpy skin disease	£90.00/ml	<b>R6001</b>
---	-----------	--------------

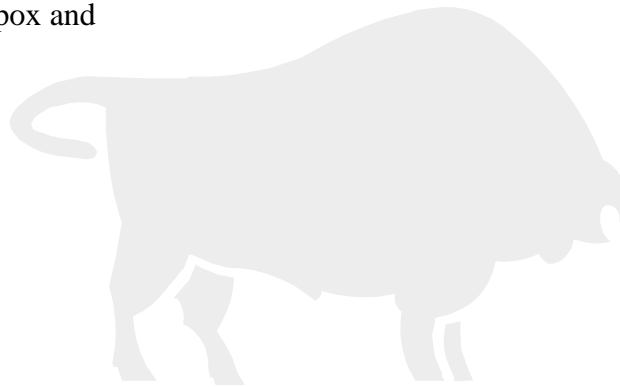

# CONDITIONS OF SALE

## 1. DEFINITIONS AND INTERPRETATION

1.1 In these Conditions of Sale the following terms shall have the following meaning:

'BACS' shall mean Bankers Automatic Clearing System.

'Catalogue' shall mean this IAH publication entitled '*Product Price List*' of which these Conditions form part.

'Clients' shall mean any person who places an order for Products or services and shall include UK and Overseas Clients.

'Conditions' shall mean the terms and conditions of sale set out in this Catalogue and any special terms and conditions agreed in writing by IAH.

'IAH' shall mean the Institute for Animal Health, the registered office of which is at Institute for Animal Health, Compton, Newbury, Berks RG20 7NN.

'EC Client' shall mean any Client whose principle place of business or registered office is in a member state of the European Union (EU) other than the UK.

'Incoterms' shall mean the Ex Works (EXW) terms of Incoterms 1990.

'Overseas Client' shall mean any Client whose principle place of business or registered office is outside the UK (and for the avoidance of doubt shall include an EU Client unless otherwise stated).

'Products' shall mean products and diagnostic services listed in this Catalogue and any products supplied to a specification agreed in writing by IAH with the Client.

'Sales Department' shall mean IAH Sales Department whose address is:

Sales Department  
Institute for Animal Health  
Pirbright Laboratory  
Ash Road, Pirbright  
Woking, Surrey, GU24 0NF  
United Kingdom

Tele: + 44 (0) 1483 24.252441

Fax: + 44 (0) 1483 24.252621

'UK' shall not for the purposes of these Conditions include the Channel Islands but shall include the Isle of Man and Northern Ireland.

'UK Client' shall mean any Client whose principle place of business or registered office is in the UK.

'VAT' shall mean Value Added Tax

- 1.2 Words denoting the singular shall include the plural and vice versa and words denoting any gender shall include both genders, whenever the context so admits.
- 1.3 All headings are for ease of reference only and shall not affect the construction of these Conditions.

## **2. CONDITIONS APPLICABLE**

- 2.1 These Conditions shall apply to all contracts for the sale of products by IAH to the Client to the exclusion of all other terms and conditions including any terms and conditions which the Client may purport to apply under any purchase order, confirmation of order or similar document.
- 2.2 All orders for Products shall be deemed to be an offer by the Client to purchase Products pursuant to these conditions.
- 2.3 Acceptance of delivery of the Products shall be deemed conclusive evidence of the Client's acceptance of these conditions.
- 2.4 Any variation to these conditions (including any special terms and conditions agreed between the parties) shall be inapplicable unless agreed in writing by IAH.

## **3. ORDERS**

- 3.1 All orders must be sent to the Sales Department and must:
  - (1) Identify all Products using the Catalogue description of the Products;
  - (2) In the case of Products to be supplied to specification, be accompanied by the proposed specification;
  - (3) Contain the full name and address of the Client for delivery (and for the invoice where this is different) including telephone, telex and facsimile numbers;
  - (4) As regards UK Clients, where the approval of the Ministry of Agriculture, Fisheries and Food is required pursuant to Condition 9.5, be accompanied by

- the requisite approval.
- (5) In the case of Overseas Clients, be accompanied with all necessary import licences and approvals or other consents (including import documents for Products classified as live and infectious as may be required to enable the Products to be imported into the Client's country).
- 3.2 Orders shall only be met if and when Conditions 3.1 is fully complied with and if they are submitted in the name of a company, firm or other corporate body. Orders from individuals cannot be accepted unless they represent one of the said bodies.
- 3.3 Orders may be placed at the Sales Department by telephone. However orders shall not be despatched until confirmation of the telephone order has been received by IAH in writing by letter or fax and marked 'Confirmation of telephone order'. Order numbers must be quoted on all correspondence.

#### **4. PRICES**

- 4.1 The price payable by the Client is the price prevailing at the date of despatch, in accordance with IAH's latest Product Price List, unless a written quotation has been provided by IAH.
- 4.2 All prices are exclusive of VAT.
- 4.3 VAT shall be added to orders from UK Clients at the rate prevailing at the date of the invoice.
- 4.4 Unless EU Clients provide a VAT registration number with their orders, VAT shall be added to EU orders at the rate prevailing in the UK at the date of invoice.
- 4.5 VAT shall not be charged on exports from the UK to Overseas Clients who are not EU Clients.
- 4.6 All and any import duties, value added taxes or other charges of whatever nature leviable or chargeable on the goods on importation into the country of destination shall be paid by the Overseas Client.
- 4.7 A handling charge of £10 shall be added to all orders less than £20 in value.
- 4.8 Delivery costs are not included in the prices in this Catalogue, and shall be charged at cost.
- 4.9 IAH reserves the right to amend prices without prior notification.
- 4.10 Samples sent for testing by airfreight from abroad, to be collected by IAH personnel

from the airport will be charged an additional £125 to cover the cost of customs clearance and collection.

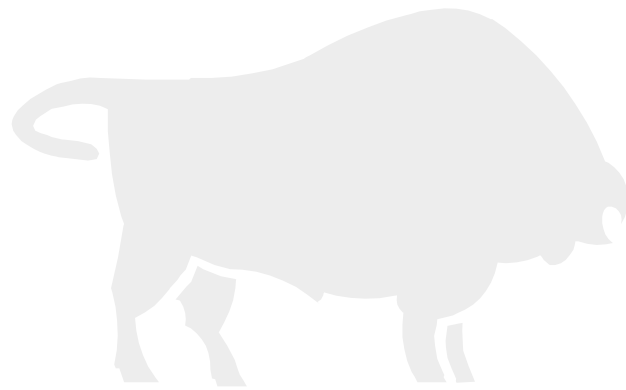

## **5. PAYMENT**

- 5.1 Payment shall be made by the Client immediately on receipt of the invoice, in sterling.
- 5.2 Payment may be made:
- 5.2.1 by bankers order or cheque drawn on a UK clearing bank made payable to 'Institute for Animal Health' - or
- 5.2.2. by BACS.
- 5.3 If payment is made by cheque, cheques must show the UK Bank Sort Code. If payment is made by BACS, a remittance advice should be sent by the Client to the Sales Desk.
- 5.4 IAH reserves the right in respect of any order to clear payment before despatch of the Products, or completion of the diagnostic service.
- 5.5 Time of payment shall be of the essence.

## **6. PROPERTY**

- 6.1 Property in each of the Products sold or agreed to be sold by IAH shall not pass to the Client until full payment of the invoice price of that Product has been received by IAH.

## **7. RISK**

- 7.1 Notwithstanding that the property in the Products may not have passed to the Client by virtue of the provisions of Condition 6, the risk in the goods shall pass:
- (1) to UK Clients on delivery of the goods;
- (2) to Overseas Clients in accordance with the Incoterms.
- 7.2 Incoterms are hereby incorporated into these Conditions of Sale and shall apply to sales with Overseas Clients, except to the extent they are modified by these Conditions. In the event of any conflict between these Conditions and the Incoterms, these Conditions shall prevail.

## **8. INSURANCE**

- 8.1 The insurable risk in the Products shall pass to the UK Client as soon as the goods are delivered to him or to his order in the case of a UK Client and in the case of an Overseas Client as soon as the Products have been delivered to the carrier in accordance with the Incoterms and pending disposal the Client shall keep the Products insured in the amount of the price at which the Products are sold to the Client against all insurable risks. If goods are destroyed by an insured risk prior to the same being paid for by the Client, the Client shall receive the proceeds of any such insurance as trustee for IAH.

## **9. THE PRODUCTS**

- 9.1 The quantity and description of the Products shall be as set out in this Catalogue and in any documentation accompanying the Products.
- 9.2 The description of the Products differentiate between those Products intended for use in *in vitro* diagnostics, research, manufacturing or quality control testing and those Products intended for use in *in vivo* diagnostic procedures or disease prophylaxis.
- 9.3 IAH warrants that the Products will at the time of delivery correspond to the description given by IAH.
- 9.4 Products shall be accompanied by documentation.
- 9.5 Where IAH supplied Products to specification agreed in writing by IAH with the Client, the Products shall conform to such specification.
- 9.6 Products are supplied on the basis that the Client is responsible for determining the suitability of the Products for the purposes for which the Client intends to use them. Some of the Products IAH are able to supply require proper precautions to be taken and the Client must ensure that any regulations relating to the storage, handling or usage of the Products are complied with.
- 9.7 The Products listed in this Catalogue are not intended for human consumption. The Client must take proper precautions against accidental ingestion or inhalation of any substances.
- 9.8 The Products are not intended for incorporation into pharmaceutical preparations and must not be used as cosmetics, agricultural or pesticidal products, food additives or household chemicals.

## **10. INTELLECTUAL PROPERTY**

10.1 The specification and design of the Products (including the copyright, design right or other intellectual property in them) shall as between the parties be the property of IAH. Where any specification or design has been supplied by the Client for manufacture by or to the order of IAH, then the Client warrants that the use of those designs or specifications for the manufacture, processing, assembly or supply of the Products shall not infringe rights (including copyright, patent trade-mark, registered or unregistered design, know-how or similar rights) of any third party and the Client shall indemnify IAH against all claims, damages, costs and expenses arising out of the infringement of such rights.

## **11. TRADEMARKS**

No trademark or name carried on any of the Products shall be erased or removed without prior written consent of IAH.

## **12. RETURNS**

12.1 Products shall not be accepted for return without the prior written approval of IAH on terms and conditions to be determined at the absolute discretion of IAH.

12.2 If the Client has any complaint in connection with the Products, the Client shall inform the Sales Department of his complaint in writing within three (3) days of receipt of the Products and the Client shall retain such Products for inspection by IAH.

12.3 Without prejudice to the other provisions of these Conditions, IAH may in its absolute discretion give consideration to any complaint made by the Client and may arrange for the Products to be replaced or for suitable allowances to be made. Any such replacements or allowances shall be made purely as a gesture of goodwill, and shall in no way be construed as an acceptance of liability by IAH.

12.4 Products returned without the prior written approval of IAH may at IAH's absolute discretion be returned to the Client or stored at the Client's cost without prejudice to any rights or remedies IAH may have.

## **13. WARNING - LIVE AND INFECTIOUS PRODUCTS**

13.1 The Client is warned that some of the Products are infectious, as indicated in the catalogue

13.2 Accordingly the Client shall ensure that:

13.2.1 He has the necessary technical skills to determine the appropriateness of the Products for the proposed application;

- 13.2.2. All necessary precautions are taken when handling live infectious Products.
- 13.2.3. Full operator safety precautions are observed when handling Products which may be infectious to humans;
- 13.2.4 Operators are fully informed as to the nature of the Products which they are handling;
- 13.2.5 Instructions in this Catalogue and any product documentation for storage, use and safe disposal of the Products are carried out.

## **14. LIABILITY**

- 14.1 All terms, conditions and warranties (whether oral or written, express or implied by statute or common law or otherwise) whether by IAH or its servants or agents or otherwise (other than express warranties set out in these Conditions) relating to the quality and/or fitness for purpose of the Products or any of the Products are excluded.
- 14.2 In any event, and notwithstanding anything contained in these Conditions, in no circumstances shall IAH be liable to contract, tort (including negligence or breach of statutory duty) or otherwise howsoever, and whatever the cause thereof, for:-
  - 14.2.1. any increased costs or expenses, and/or
  - 14.2.2. any loss of profit, business, contracts, revenues, or anticipated savings, and/or
  - 14.2.3. for any special direct or consequential damage of any nature whatsoever.
- 14.3 In any event, and notwithstanding anything contained in these Conditions, IAH's liability in contract, tort (including negligence or breach of statutory duty) or otherwise howsoever, and whatever the cause thereof, arising by reason of or in connection with this contract shall be limited to the invoice price of the Product.
- 14.4 Without prejudice to the generality of Conditions 14.2 and 14.3, in no circumstances shall IAH be liable in contract, tort (including negligence) or otherwise howsoever for any loss or damage of any kind whatever arising from:
  - 14.4.1 the use of the Products by the Client; and/or
  - 14.4.2 the inaccuracy of results obtained from the Products; and/or
  - 14.4.3 the failure of the Client to observe the warnings contained in Condition 13
- 14.5 The Client shall indemnify IAH against all actions, proceedings, claims, or demands in any way connected with the contract brought or threatened against the Client by a third party except to the extent that IAH is liable to the Client under these Conditions.

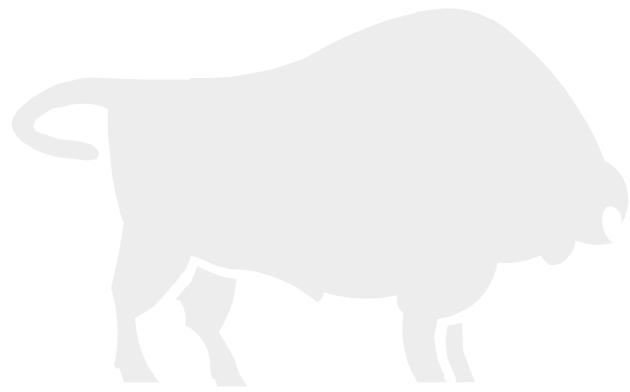

14.6 Each of the foregoing Conditions 14.1 to 14.5 is to be construed as a separate limitation (applying and surviving even if for any reason one or other of the said Conditions is held inapplicable or unreasonable in any circumstances) and shall remain in force notwithstanding completion of the contract to which these Conditions relate.

## **15. DELIVERY**

15.1 Whereas every effort shall be made to meet any time, date or period named for delivery or completion of tests, any such time, date or period is an estimate only and IAH shall not be liable for any damage or loss of any nature whatsoever (including loss or damage in transit) whether arising directly or indirectly out of delay in delivery or completion of tests unless such delay is substantial and can be proved to result from the negligence of IAH and such late despatch of delivery or completion of tests will not entitle the Client to rescind the contract.

15.2 IAH reserves the right to make delivery of goods by instalments and to tender a separate invoice for each instalment setting out the invoice price for each instalment. Payment for any such instalment must be made in accordance with Condition 5 and any delay in the delivery of any instalment shall not entitle the Client to refuse to accept delivery of further instalments.

## **16. LOSS IN TRANSIT**

IAH shall not be liable for any loss or damage whatever of Products in transit, unless it can be proved to result from the negligence of IAH.

## **17. IMPORT DOCUMENTS**

The Overseas Client shall be responsible for obtaining and maintaining in force all necessary import licences and approvals or other consents (including import documents for Products classified as live and infectious Products) as may be required to enable the Products to be imported into the Client's country.

## **18. STORAGE**

Where despatch of goods is delayed at the Client's request or by reason of the Client's failure to give proper instructions as to delivery, IAH shall be entitled to arrange storage either at its own works or elsewhere and all charges or storage insurance shall be paid by the Client.

## **19. CANCELLATION BY CLIENT**

When a contract has been made between IAH and the Client, the Client shall not be entitled to cancel the contract except with the prior written consent of IAH and on terms which will indemnify IAH against all loss or damage whether direct or indirect.

## **20. CANCELLATION BY IAH**

IAH may cancel this contract at any time before the Products are delivered by given written notice. On giving such notice, IAH shall promptly repay to the Client any sums paid in respect of the Price.

## **21. NOTICES**

- 21.1 Any notices given under or pursuant to these Conditions shall be in writing and sent by hand or by first-class post or registered post or by recorded delivery or transmitted by facsimile if so sent or transmitted to IAH at the address of its Sales Desk, or such other address as IAH may from time to time notify to the Client, and to the Client at its registered office or principal place of business, shall be deemed effectively given on the day when the ordinary course of the means of transmission it would first be received by the addressee in normal business hours.
- 21.2 A party shall not attempt to prevent or delay the service on it of a notice under these Conditions.

## **22. FORCE MAJEURE**

- 22.1 Neither party shall be liable for delay in performing or failure to perform obligations if the delay or failure results from any industrial dispute, Act of God, war, civil commotion, legislation, inability to obtain supplies, raw materials, equipment or transportation, inability to obtain any necessary import or export licences or other consents or approvals of any governmental authority, or any other cause or circumstances whatsoever beyond its control.
- 22.2 Such delay or failure shall not constitute a breach of contract and the time for performance shall be extended by a period equivalent to that during which performance is so prevented provided that if such delay or failure persists for more than six (6) months nothing in this Condition 22.2 shall be taken to limit or prevent the exercise by IAH of its rights of cancellation under Condition 20.

## **24.25. SUB-CONTRACTING**

IAH may licence or sub-contract all or any part of its rights and obligations under this contract without the Client's consent.

## **24. WAIVER**

No waiver or forbearance by IAH (whether express or implied) in enforcing any of its rights under this contract shall prejudice its right to do so in the future.

## **25. SEVERANCE**

Any provision in these Conditions which is or may be void or unenforceable shall to the extent of such invalidity or unenforceability be deemed severable and shall not affect any other provision of these Conditions.

## **26. PROPER LAW**

These Conditions shall be governed by and construed in accordance with English Law.

## **27. JURISDICTION**

All disputes arising out of this contract shall be subject to the exclusive jurisdiction of the English courts. This Condition is for the sole benefit of IAH and shall not be construed so as to limit the rights of IAH to take proceedings against the Client in any court of competent jurisdiction, nor shall the taking of proceedings in any one or more jurisdictions preclude the taking of proceedings in any other jurisdiction, whether concurrently or not.

